

Project Name	Mai Shayi
Project Code	
Job Order Number	

Out door BAR

ELVB

Item Description	Qty Required	UOM
	1	Pcs
Height	Width	Thickness
770	770	750

Date

8/7/2024

All Measurements are in millimetres

	SF	SF Description	Parts Description	Length	Width	Thickness	Qty	Remarks
1	SF000-1	Wall B	Side	<u>767</u>	<u>747</u>	18	2	WS05
2	SF000-1	Wall B	Bottom	<u>734</u>	747	18	1	WS05
3	SF000-1	Wall B	Top	<u>734</u>	747 722	18	1	WS05
4	SF000-1	Wall B	Back	<u>734</u>	97	18	2	WS05
5	SF000-1	Wall B	Back	750	754	18 8	1	WS05
6	SF000-1	Wall B	Shelf	<u>734</u>	<u>711</u>	18	2	WS05

Project Name		Mai Shayi
Project Code		
Job Order Number		

Out door BAR

ELVD

Item Description	Qty Required	UOM
	1	Pcs
Height	Width	Thickness
770	1115	750

Date

8/7/2024

All Measurements are in millimetres

	SF	SF Description	Parts Description	Length	Width	Thickness	Qty	Remarks
1	SF000-1	Wall B	Side	767	747	18	2	WS05
2	SF000-1	Wall B	Bottom	1079	747	18	1	WS05
3	SF000-1	Wall B	Top	1079	747	18	1	WS05
4	SF000-1	Wall B	Back	1079	97	18	2	WS05
5	SF000-1	Wall B	Back	750	1099	18	1	WS05
6	SF000-1	Wall B	Shelf	1079	711	18	2	WS05

Project Name	Mai Shayi
Project Code	
Job Order Number	

Out door BAR

ELV

Item Description	Qty Required	UOM
	1	Pcs
Height	Width	Thickness
770	1224	750

Date 8/7/2024

All Measurements are in millimetres

SF	SF Description	Parts Description	Length	Width	Thickness	Qty	Remarks
1	SF000-1	Wall Side	767	747	18	2	WS05
2	SF000-1	Wall Bottom	1188	747	18	1	WS05
3	SF000-1	Wall Top	1188	747 722	18	1	WS05
4	SF000-1	Wall Back	1188	97	18	2	WS05
5	SF000-1	Wall Back	750	1208	18 18	1	WS05
6	SF000-1	Wall Shelf	585	711	18	4	WS05
		Middle side	734	744	18	1	WS05

Project Name	Mai Shavi
Project Code	
Job Order Number	

Out door BAR
 SMT
 ELV

Item Description	Qty Required	UOM
Height	1	Pcs
Width	1000	Thickness
770		600

Date 8/7/2024

All Measurements are in millimetres

SF	SF Description	Parts Description	Length	Width	Thickness	Qty	Remarks
1	SF000-1	Wall B Side	767 767	577 577	18	2	WS05
2	SF000-1	Wall B Bottom	964 964	577	18	1	WS05
3	SF000-1	Wall B Top	964 964	97	18	2	WS05
4	SF000-1	Wall B Back	964 964	97	18	4	WS05
		Door	767 767	497	18	2	WS05

Project Name	Mai Shayi
Project Code	
Job Order Number	

Out door BAR
elva

Date 8/7/2024

Item Description	Qty Required	UOM
	1	Pcs
Height	Width	Thickness
770	500	600

All Measurements are in millimetres

SF	SF Description	Parts Description	Length	Width	Thickness	Qty	Remarks
1	SF000-1	Wall B	767	577	18	2	WS05
2	SF000-1	Wall B	464	577	18	1	WS05
3	SF000-1	Wall B	464	577	18	1	WS05
4	SF000-1	Wall B	464	97	18	2	WS05
5	SF000-1	Wall B	750	484	18	1	WS05
6	SF000-1	Wall B	464	567	18	1	WS05
		Door	767	495	18	1	WS05

Project Name	Mai Shayi
Project Code	
Job Order Number	

Out door BAR

ELVE

Item Description	Qty Required	UOM
	1	Pcs
Height	Width	Thickness
770	1000	600

All Measurements are in millimetres

	SF	SF Description	Parts Description	Length	Width	Thickness	Qty	Remarks
1	SF000-1	Wall B	Side	767	577	18	2	WS05
2	SF000-1	Wall B	Bottom	964	577	18	1	WS05
3	SF000-1	Wall B	Top	964	577	18	1	WS05
4	SF000-1	Wall B	Back	964	97	18	2	WS05
5	SF000-1	Wall B	Back	750	984	18	1	WS05
6	SF000-1	Wall B	Shelf	964	567	18	1	WS05
			Door	767	497	18	2	WS05

Date

8/7/2024

PIPE

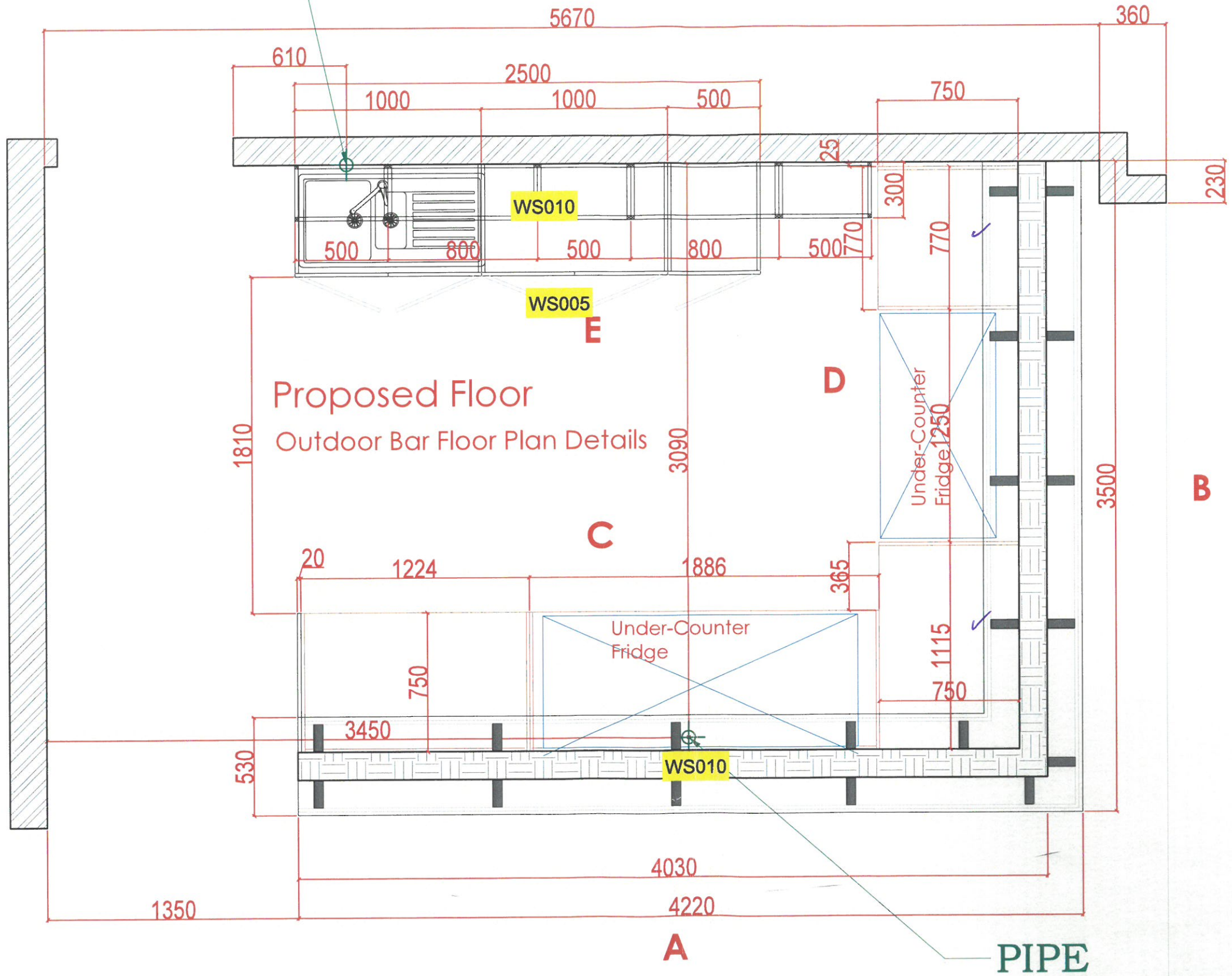

Proposed Floor
Outdoor Bar Floor Plan Details

Project
**MAI SHAYI CAFE
ABUJA.**

Owner

Date	Description
DSD-V1-ID-30/4/2024	- REV1
DSD-V1-ID-11/7/2024	- REV2

FOR APPROVAL

Project No. : --
 Scale : N/A
 Drawn by : OBJ
 Checked : OBJ
 Cad File : CAD_FILE

Sheet title
**GROUND FLOOR
 MAI SHAYI CAFE
 OUTDOOR BAR**
 Floor Plan / Elevation

Dwg No. WS-DS-SD-MS-006	No. SHEET 1
----------------------------	----------------

Project
**MAI SHAYI CAFE
 ABUJA.**

Owner

Date	Description
DSD-V1-ID-30/4/2024	REV1
DSD-V1-ID-11/7/2024	REV2

FOR APPROVAL

Project No. : ---
 Scale : N/A
 Drawn by : OBJ
 Checked : OBJ
 Cad File : CAD_FILE

Sheet title
 GROUND FLOOR
 MAI SHAYI CAFE
 OUTDOOR BAR
Elevation-B

Dwg No. WS-DS-SD-MS-006	No. SHEET 3
-----------------------------------	-----------------------

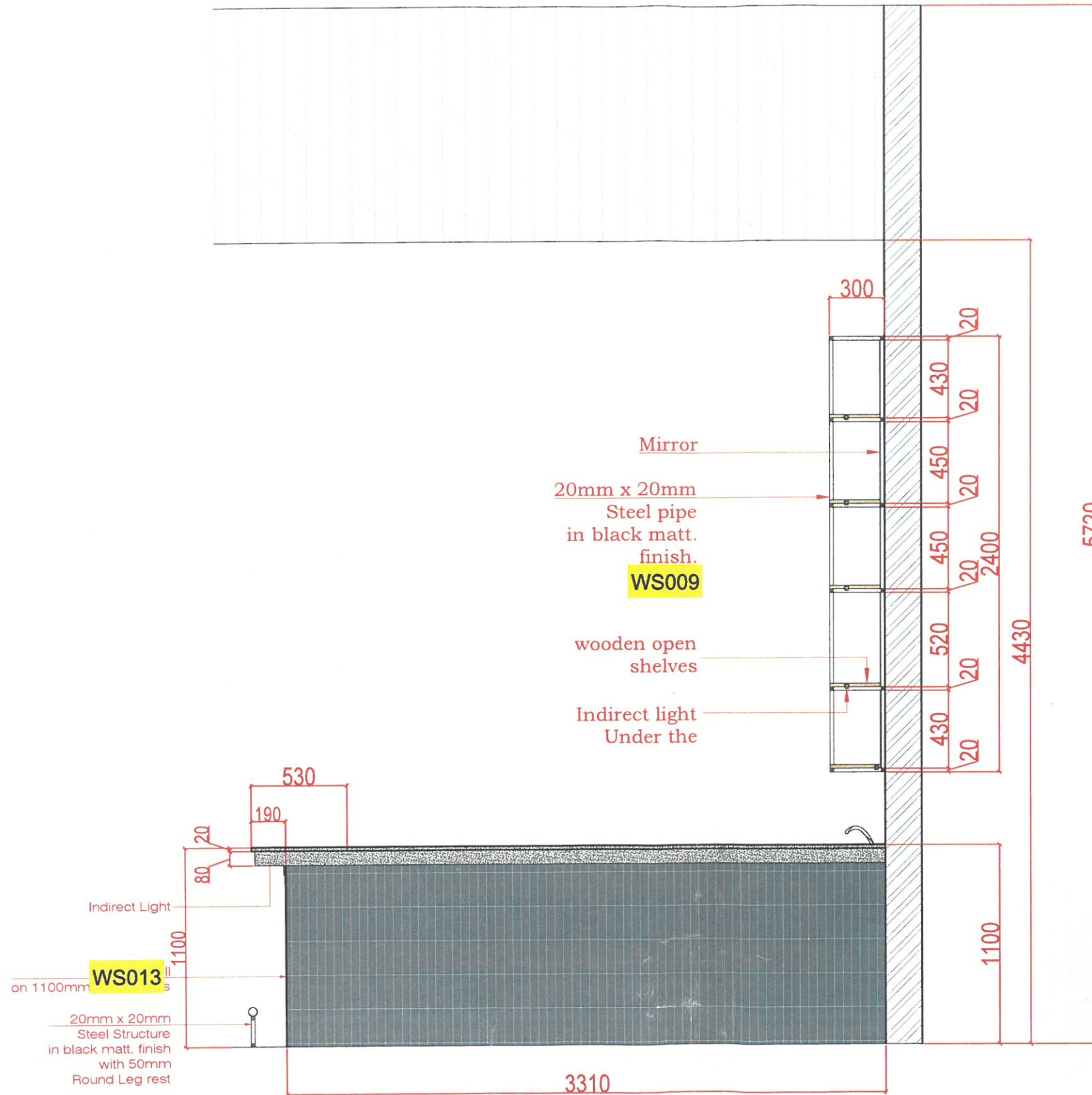

Elevation - B

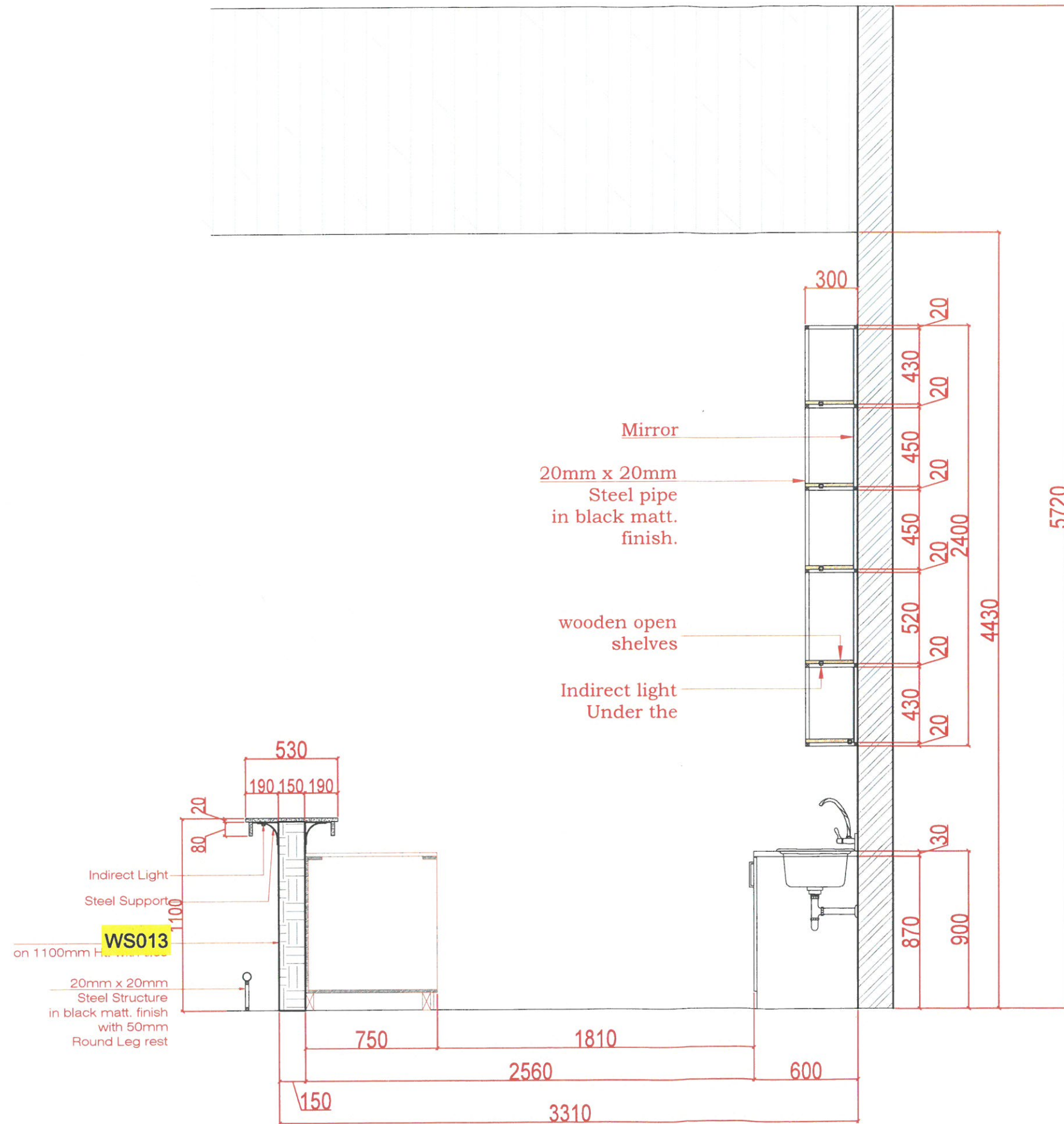

Sectional Details

FOR APPROVAL

Project No. : —
Scale : N/A
Drawn by : OBJ
Checked : OBJ
Cad File : CAD_FILE

Sheet title
GROUND FLOOR
MAI SHAYI CAFE
OUTDOOR BAR
Sectional Details

Dwg No. : WS-DS-SD-MS-006

No. : SHEET 7

FOR APPROVAL

Project No. : —
Scale : N/A
Drawn by : OBJ
Checked : OBJ
Cad File : CAD_FILE

Sheet title
**GROUND FLOOR
MAI SHAYI CAFE
OUTDOOR BAR
Back Bar Display Steel Shelves**

Dwg No. WS-DS-SD-MS-006	No. SHEET 8
-----------------------------------	-----------------------

**Back Bar Display 20mm x 20mm
Steel Open Shelves**



20mm x 20mm
Steel pipe
in black matt.
finish.

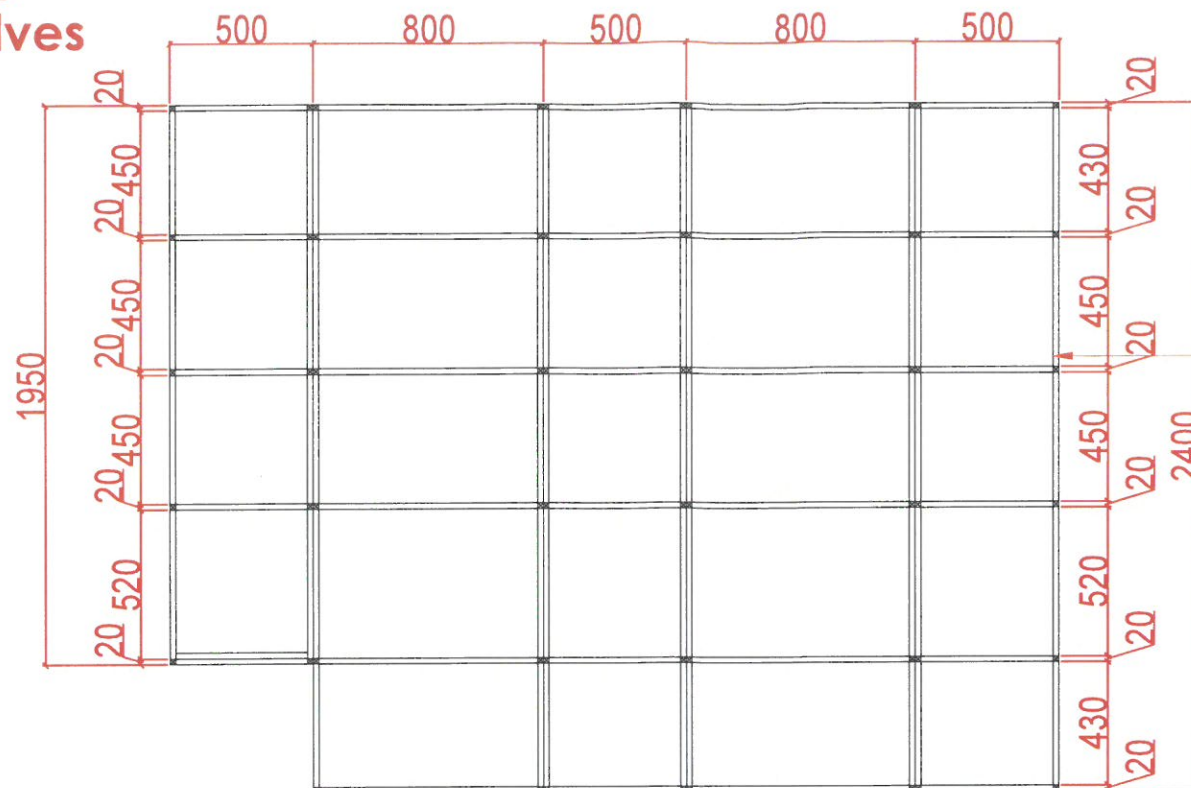

20mm x 20mm
Steel pipe
in black matt.
finish.

Side Elevation

Front Elevation

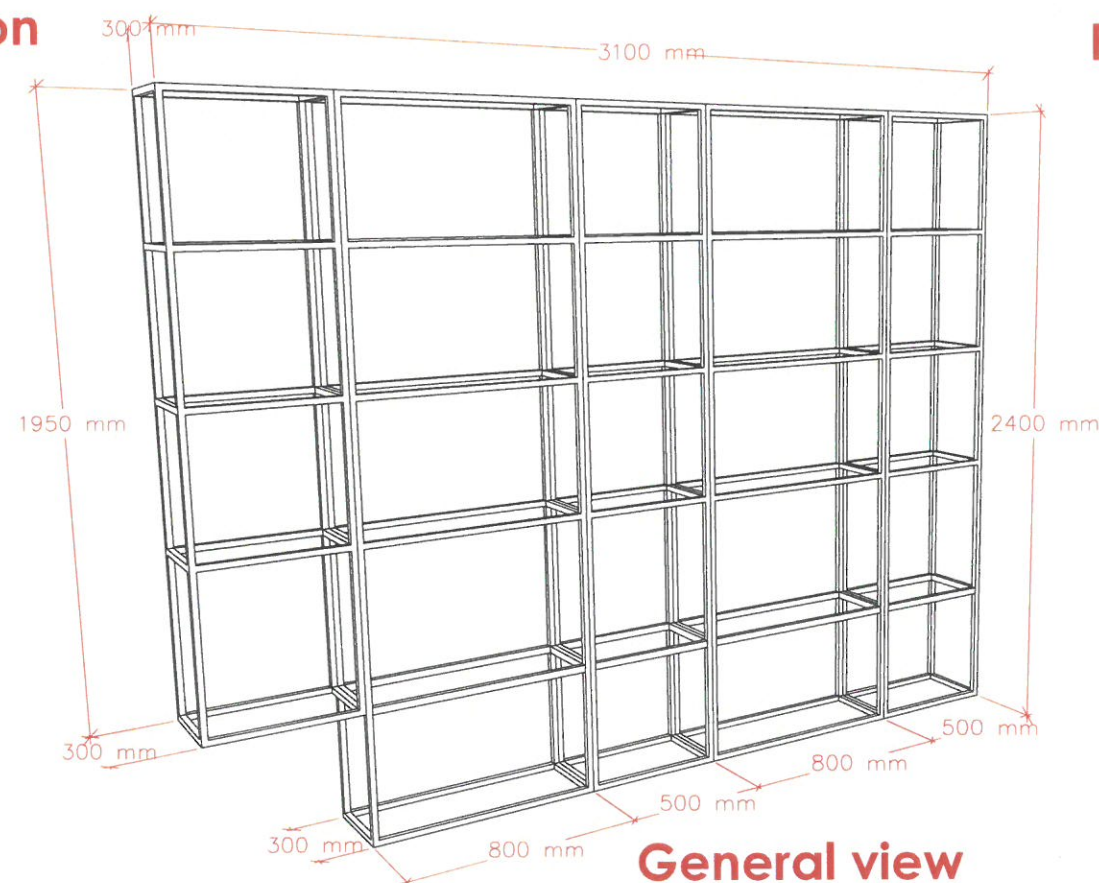

General view

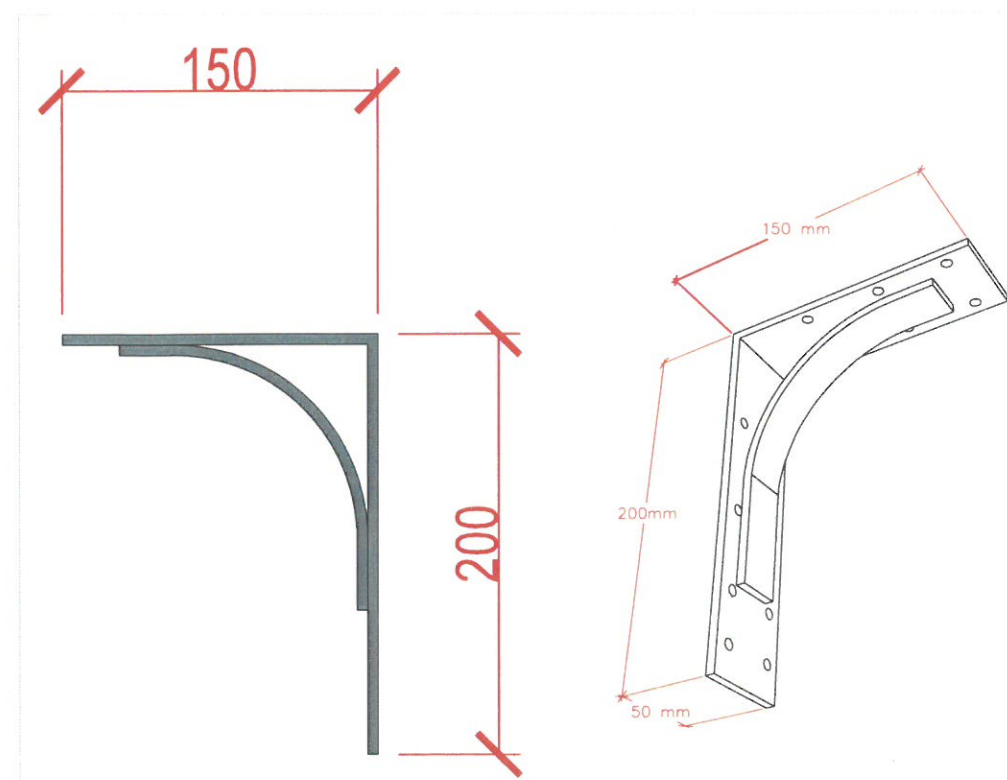

**19pcs
Steel Support**

Project
**MAI SHAYI CAFE
ABUJA.**

Owner
—

Date	Description
DSD-V1-ID-30/4/2024	REV1
DSD-V1-ID-11/7/2024	REV2

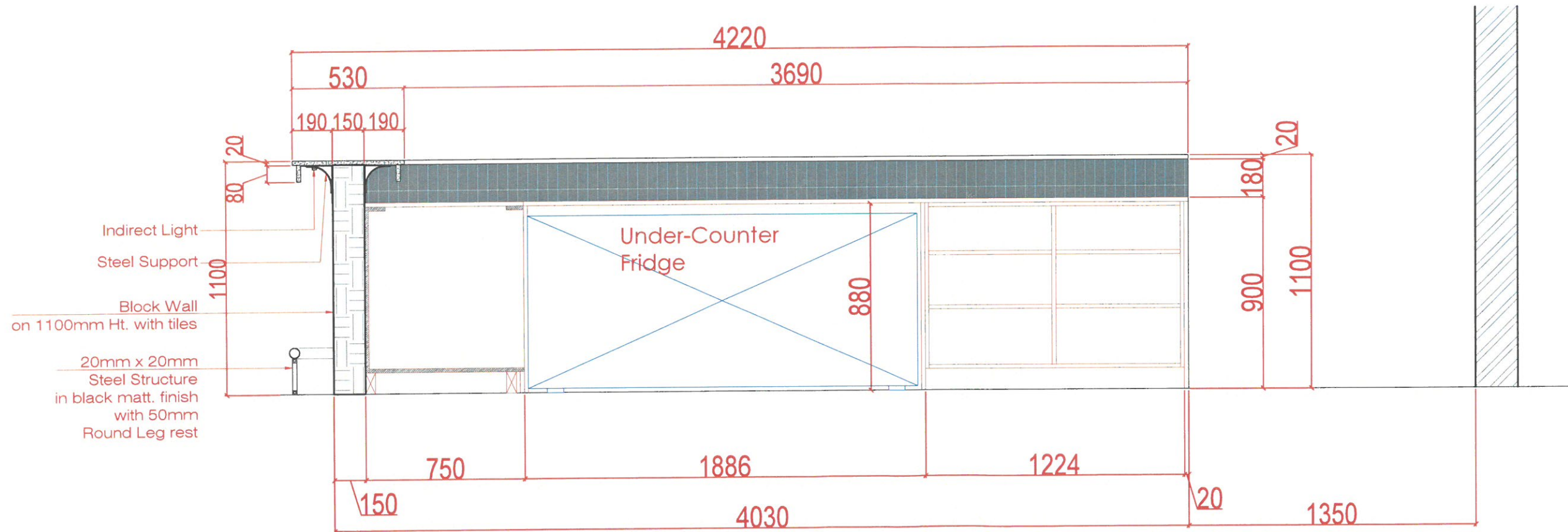

Elevation - C

FOR APPROVAL

Project No. : —
Scale : N/A
Drawn by : OBJ
Checked : OBJ
Cad File : CAD_FILE

Sheet title
**GROUND FLOOR
MAI SHAYI CAFE
OUTDOOR BAR
Elevation-C**

Dwg No. WS-DS-SD-MS-006	No. SHEET 4
-----------------------------------	-----------------------

Project
**MAI SHAYI CAFE
ABUJA.**

Owner

Date	Description
DSD-V1-ID-30/4/2024	REV1
DSD-V1-ID-11/7/2024	REV2

FOR APPROVAL

Project No. : ---
Scale : N/A
Drawn by : OBJ
Checked : OBJ
Cad File : CAD_FILE

Sheet title
**GROUND FLOOR
MAI SHAYI CAFE
OUTDOOR BAR
Elevation- D**

Dwg No.
WS-DS-SD-MS-006

No.
SHEET 5

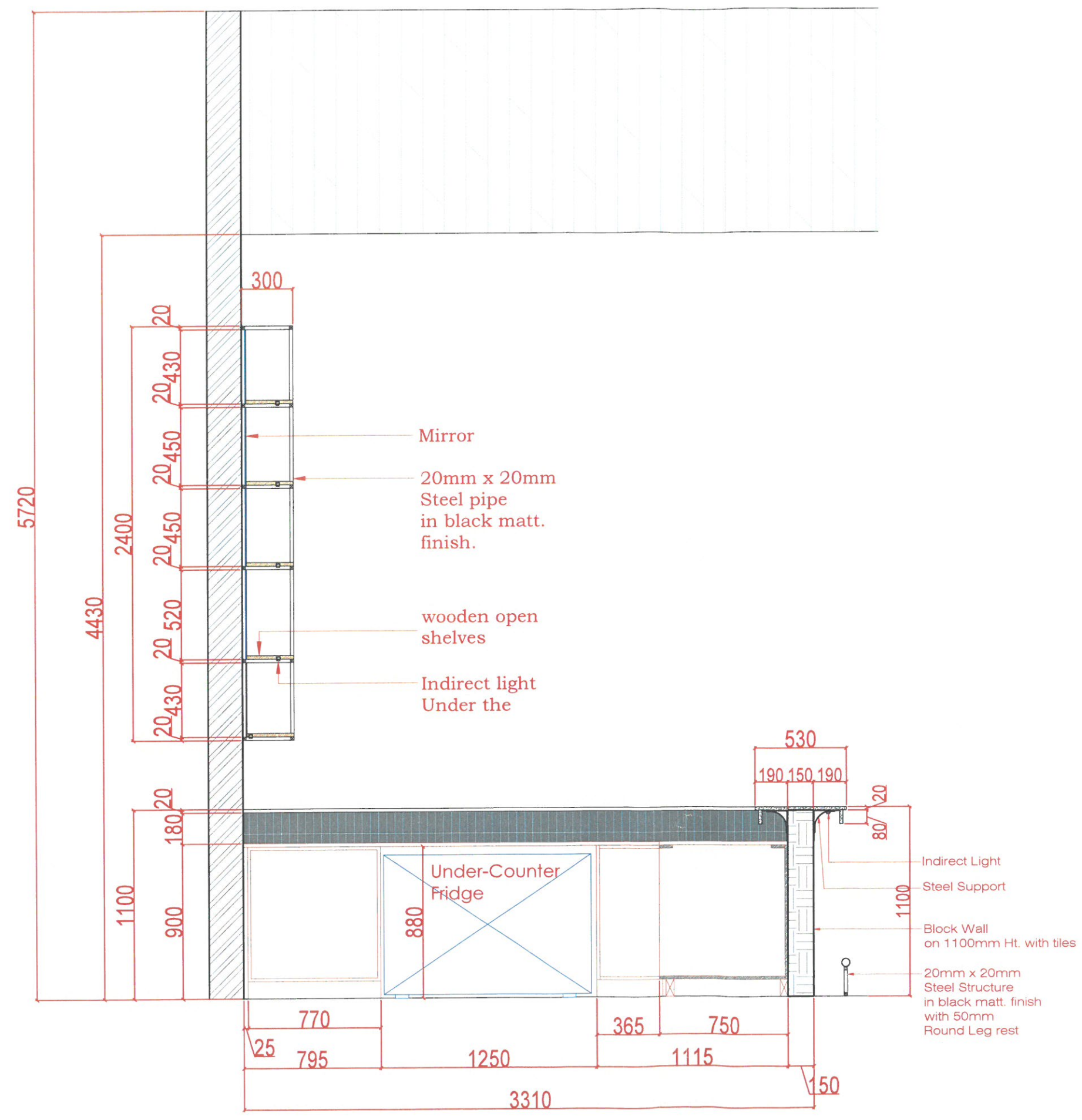

Elevation - D

